

TONE[®] NUT RUNNER

**TO BE
PRESERVED**

INSTRUCTION MANUAL

No. 1705

MODEL

GNBC81E-UC / GNBC121E-UC / GNBC211E-UC

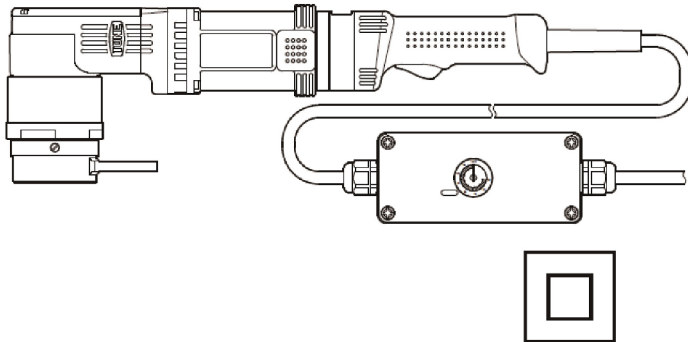

Double Insulation

⚠ CAUTION

Read and fully understand all the instructions before use.
Keep this manual in designated place for easy and quick reference.
The models mentioned in this manual are designed for use outside Japan.
Warranty shall be void if above mentioned models are used in Japan.

TONE CO., LTD.

PREFACE

Thank you for purchasing the **NUT RUNNER**.

- Upon receipt, check and confirm the following:

- Check for any damage.
- Check for any loose or missing screws and bolts.
- Check the model as per order.
- Check all the accessories are contained. (⇨ P.15~18)

If any problems are found, contact your distributor.

- Read this instruction manual carefully before use.

Full understanding of manual is essential to prevent personal injury or malfunction.

- Keep this manual in the metal case for reference.

- If the manual or warning label is lost or becomes illegible, or if an additional manual is required, contact your distributor.

If you have any questions about the products or the contents of this instruction manual, contact your distributor.



- This manual is only applicable outside Japan.

SAFETY INSTRUCTION

This manual specifies three (3) basic safety instructions:



Instructions are classified by degree of risk and described as follows:

	Danger is used to indicate threatening dangerous or unsafe practices which could immediately result in severe personal injury or death in the worst case.
	Warning is used to indicate hazardous or unsafe practices which could result in severe personal injury or death in the worst case.
	Caution is used to indicate hazardous or unsafe practices which could result in personal injury, product or property damage.



Even if the risk is classified as  , the risk could become more serious depending on the conditions. Make sure to follow all instructions when operating these tools.

TABLE OF CONTENTS

1. GENERAL SAFETY INSTRUCTIONS.....	4
2. APPLICATION.....	7
3.  PRECAUTIONS FOR USE	7
4. PART NAME & ACCESSORIES	15
5. BEFORE USE	19
6. CHANGING ACCESSORIES	21
7. OPERATING PROCEDURE	23
8. TIGHTENING TORQUE	26
9. EXPLANATION LED INDICATION	28
10. INSPECTION & MAINTENANCE	29
11. FEATURE	30
12. SPECIFICATIONS	31
13. AFTER SALES SERVICE	32

1. GENERAL SAFETY INSTRUCTIONS

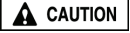
WARNING

When using electric tools, basic safety precautions, including the following, should always be followed to reduce the risk of fire, electric shock and personal injury. Read all instructions before operating this product and keep the instructions for future reference.

SAVE THESE INSTRUCTIONS

1) Work area

- a) Keep work area clean and well lit. Cluttered and dark areas invite accidents.
- b) Do not operate power tools in explosive atmospheres, such as in the presence of flammable liquids, gases or dust. Power tools create sparks which may ignite the dust or fumes.
- c) Keep children and bystanders away while operating a power tool. Distractions can cause you to lose control.

2) Electrical safety

- a) Power tool plugs must match the outlet. Never modify the plug in any way. Do not use any adapter plugs with earthed (grounded) power tools. Unmodified plugs and matching outlets will reduce risk of electric shock.
- b) Avoid body contact with earthed or grounded surfaces such as pipes, radiators, ranges and refrigerators. There is an increased risk of electric shock if your body is earthed or grounded.
- c) Do not expose power tools to rain or wet conditions. Water entering a power tool will increase the risk of electric shock.
- d) Do not abuse the cord. Never use the cord for carrying, pulling or unplugging the power tool. Keep cord away from heat, oil, sharp edges or moving parts. Damaged or entangled cords increase the risk of electric shock.

- e) When operating a power tool outdoors, use an extension cord suitable for outdoor use. Use of a cord suitable for outdoor use reduces the risk of electric shock.

3) Personal safety

- a) Stay alert, watch what you are doing and use common sense when operating a power tool. Do not use a power tool while you are tired or under the influence of drugs, alcohol or medication.
A moment of inattention while operating power tools may result in serious personal injury.
- b) Use safety equipment. Always wear eye protection. Safety equipment such as dust mask, non-skid safety shoes, hard hat, or hearing protection used for appropriate conditions will reduce personal injuries.
- c) Avoid accidental starting. Ensure the switch is in the off position before plugging in. Carrying power tools with your finger on the switch or plugging in power tools that have the switch on invites accidents.
- d) Remove any adjusting key or wrench before turning the power tool on. A wrench or a key left attached to a rotating part of the power tool may result in personal injury.
- e) Do not overreach. Keep proper footing and balance at all times. This enables better control of the power tool in unexpected situations.
- f) Dress properly. Do not wear loose clothing or jewelry. Keep your hair, clothing and gloves away from moving parts. Loose clothes, jewelry or long hair can be caught in moving parts.
- g) If devices are provided for the connection of dust extraction and collection facilities, ensure these are connected and properly used. Use of these devices can reduce dust related hazards.

4) Power tool use and care

- a) Do not force the power tool. Use the correct power tool for your application. The correct power tool will do the job better and safer at the rate for which it was designed.
- b) Do not use the power tool if the switch does not turn it on and off. Any power tool that cannot be controlled with the switch is dangerous and must be repaired.
- c) Disconnect the plug from the power source before making any adjustments, changing accessories, or storing power tools. Such preventive safety measures reduce the risk of starting the power tool accidentally.
- d) Store idle power tools out of the reach of children and do not allow persons unfamiliar with the power tool or these instructions to operate the power tool. Power tools are dangerous in the hands of untrained users.
- e) Maintain power tools. Check for misalignment or binding of moving parts, breakage of parts and any other condition that may affect the power tools operation. If damaged, have the power tool repaired before use. Many accidents are caused by poorly maintained power tools.
- f) Keep cutting tools sharp and clean. Properly maintained cutting tools with sharp cutting edges are less likely to bind and are easier to control.
- g) Use the power tool, accessories and tool bits etc., in accordance with these instructions and in the manner intended for the particular type of power tool, taking into account the working conditions and the work to be performed. Use of the power tool for operations different from intended could result in a hazardous situation.

5) Service

- a) Have your power tool serviced by a qualified repair person using only identical replacement parts. This will ensure that the safety of the power tool is maintained.

2. APPLICATION

■ **NUT RUNNER** is an electric tool for tightening hexagonal bolts.

3. PRECAUTIONS FOR USE

■ To prevent accidents or personal injury read and follow all instructions listed below.

DANGER

- **Beware of electric shock when operating at elevated heights.**
- Failure to follow these instructions may result in fall down accidents.

— **About Double Insulation** —

This electric wrench has a double insulation structure. An electric conductor portion is insulated by two insulators which enhances safety against electric shock. The electric wrenches that have double insulated structure are clearly marked with  (Double Insulation Mark) on the rating plate.

DANGER

- **Never put hand in the turning circle of reaction bar during operation. The reaction bar rotates in the reverse direction.**

○ If the wrench is started, the reaction bar will turn in the direction opposite to the rotation of nut. There is a risk that finger might be pinched by reaction bar and reaction-member.

Negligence might cause accidents or injury.

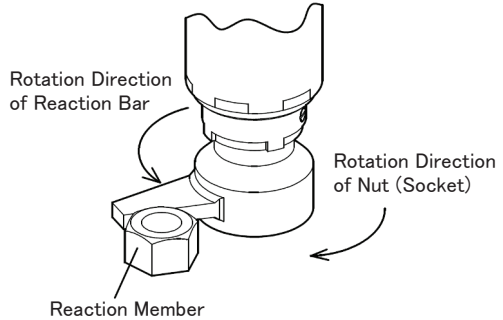

WARNING

- **Insert socket securely to the depth of nut.**

○ If insufficient, it might damage socket and cause personal injury.

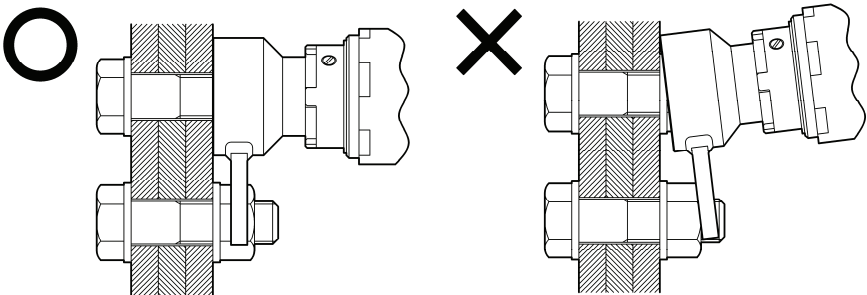

Negligence might cause accident, breakage or injury.

 **WARNING**

● **Beware of electric shock.**

- Never use the wrench when moisture is present such as rain or snow.
- Never touch the plug with wet hands.

Failure to follow these instructions may result in electric shock, fire or electric leakage.

● **Firmly hold the wrench with both hands during operation.**

- The wrench automatically shuts off when snug tightening is completed. Prepare for automatic shut off by firmly holding the wrench with both hands as the reaction force maximizes just before automatic shut off.

Failure to follow these instructions may result in personal injury.

● **Electric cord must be regularly inspected.**

- Stop using the wrench if there is a problem with the electric cord.
- Contact your distributor for repair.

Failure to follow these instructions may result in electric shock or electric leakage.

● **Never use the wrench in an area where gasoline, gas, thinner, benzene, etc., are stored.**

- Do not use the wrench around flammable substances to avoid accidental fire caused by the spark out of the electric motor.

● **Beware of falling accidents when working at elevated heights.**

- Wear safety belt.
- Provide safety net or canvas as safe guarding against falling items.
- Confirm that no one is underneath the working site before operation.
- Stop operation when physically or mentally tired.

Failure to follow these instructions may result in accidents.

 **WARNING**

● **Avoid overloading.**

- Use the wrench and its accessories within the rated specifications. An overloaded wrench and its accessories may result in the malfunction of the wrench which may cause accidents or personal injury.

● **Properly install the sockets as described in this manual.**

- Incomplete installation may result in accident and personal injury. See “CHANGING ACCESSORIES” on page (↪ P.21)

● **Avoid accidental Starting**

- Ensure that the switch is in the off-position before plugging into a power source.
- Never carry the wrench with your fingers on the switch when the plug is connected to a power source.

● **Disconnect the plug from the power source when:**

- Not in use.
- Changing accessories.
- Performing inspection and maintenance.
- Or other danger is foreseen.

Failure to follow these instructions may result in accidental starting and personal injury.

● **Do not disassemble or modify the wrench.**

- Disassembly or modification made by unauthorized personnel may result in malfunction or personal injury.
- Disassembly and Re-assembly is permitted for the following consumable parts: Sockets, Set Screws, Brush Caps, and Carbon Brushes.

 **WARNING**

● **Store the wrench in the metal case and place it in protected storage when not in use.**

- Store the wrench in a secure, dry location to keep any unauthorized personnel away.

Failure to follow these instructions may result in malfunction or accidents.

● **Immediately stop using the wrench and disconnect the plug when unusual sound, vibration or smell is detected.**

- Contact your distributor immediately.

Failure to follow these instructions may result in serious injury.

● **Contact your distributor for repair service.**

- Repair work should only be carried out by a qualified technician.
- Repair work done by an inexperienced person may cause accidents, injury or malfunction.

● **Check the following items before operation.**

- Check for any deformation, crack or damage on the wrench body, sockets, accessories, electric cord, plug, etc.
- Make sure that sockets are correctly installed on the wrench.
- Make sure that set screws are securely fastened. Loose installation may result in accidents and personal injury.
- Do not use the wrench if any problems are found on the items listed above.

Failure to follow these instructions may result in electric shock, fire or burn accidents.

● **Use appropriate power source as indicated on the rating plate.**

Failure to follow these instructions may result in fire or burn accidents.

WARNING

● Immediately check the wrench if it is dropped or impacted.

- Check for deformation, crack, damage and other abnormality. Stop using the wrench if any abnormality is found.
- Do not use the wrench if any problems are found.

Failure to follow these instructions may result in electric shock, fire or burn accidents.

CAUTION

● Use Commercial power supply to operate the wrench.

● Follow the instructions below when using generator.

- Use 50–60Hz (AC) sinusoidal power supply without high harmonic wave.
Power supply including high harmonic wave may cause malfunction or breakage of the wrench.
- Use high capacity generator.
Power requires almost 2kW (2kVA) per one month.
- The operating voltage must remain within +/-10% of the rated voltage at all times.
- Do not use an inverter generator.
(Inverter generator: The engine rpm will speed up and slow down automatically due to the wattage being pulled from the generator.)

Failure to follow these instructions may cause malfunction or breakage of the wrench.

● Do not use welder generators.

- Welder generators may cause malfunction or breakage of the control base installed in the wrench.
- Some welder generators may produce electrical noise that may cause the wrench to malfunction.

CAUTION

● Do not use welders along with the wrench.

- The wrench may malfunction due to extraordinary electrical noise even if the welders are connected to other generators that the wrench is not connected to.

● Keep work area clean.

- Cluttered areas and benches invite accidents.

● Keep children away.

- Do not let children touch the wrench or electric cord.
- All visitors should be kept away from work area.

● Secure work area.

- Keep body stance balanced and firm.
- Never wrap the electric cord around something.
- Keep work area well lit.

● Use suitable model for each application.

- Do not use the wrench beyond its rated specifications.
- Do not use the wrench for unintended purposes.

● Dress properly.

- Always wear gloves and non-skid shoes when operating.
- Always wear safety helmet.

● Use genuine accessories and attachments manufactured by TONE CO., Ltd.

- Use the genuine accessories mentioned in this instruction manual or TONE's general catalog.

Failure to follow these instructions may result in malfunction or accidents.

CAUTION

- **Do not connect multiple plugs to a single outlet by using a multiple outlet adaptors.**

Over current may cause fire, accidents or malfunction.

- **Do not abuse the electric cord.**

- Never use the electric cord for carrying, pulling or unplugging the power.
- Keep the electric cord away from heat, oil, sharp edges or moving parts.

- **Keep electric motor well ventilated.**

- Do not put any foreign materials into the vent.
- Do not block exhaust vent.

- **Maintain wrench.**

- Keep the wrench handle clean, dry and free of oil or grease.

- **Provide leakage breaker as a shock guard for each wrench.**

- Although a double insulated wrench does not require a leakage breaker, use of leakage breaker is strongly recommended as an extra safeguard.

- **When using an extension cord, make sure that voltage remains within +/- 10% of the rated voltage at all times.**

- **When using an extension cord, select shorter extension units than specified below depending on the cross section.**

Nominal conducting cable cross section.	Max. Length
	110–120V
AWG 14	50ft
AWG 12	80ft
AWG 10	130ft

- Using an extension cord longer than the Maximum Length listed above may result in a malfunction or breakdown due to performance drop of the wrench.

- **Observe local laws and rules concerning noise level.**

4. PART NAME & ACCESSORIES

Part Name

Main Body

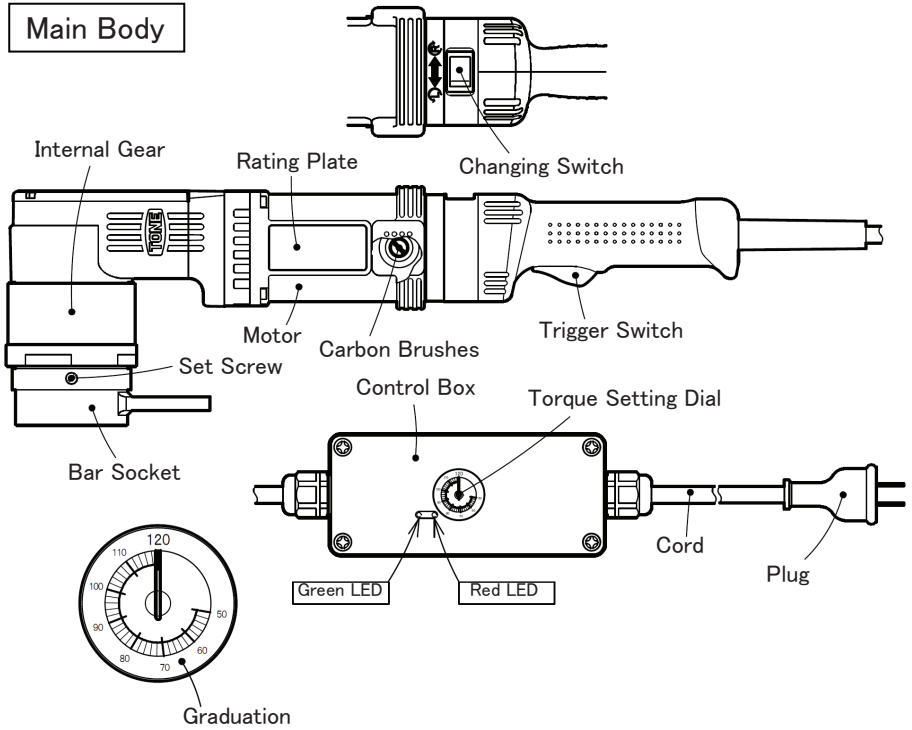

Accessory

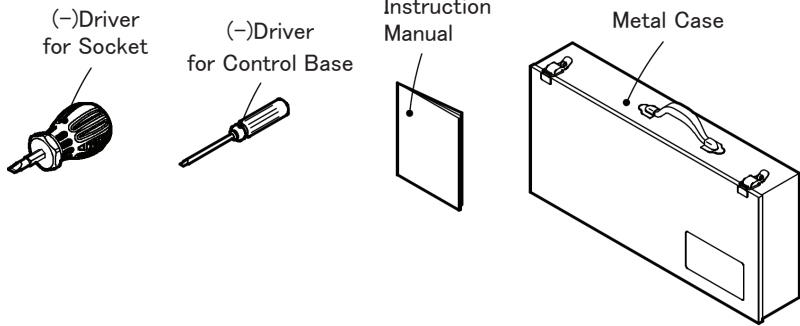

Accessories

Model	Bar Socket	Accessories
GNBC81E-UC GNBC82E-UC	22UR36T	·(-)Driver For Bar Socket For Torque Setting Dial ·Metal Case ·Instruction Manual
GNBC121E-UC GNBC122E-UC	24UR41T	
GNBC211E-UC GNBC212E-UC	30UR50T	

Optional Accessories

Model	
GNBC81E-UC GNBC82E-UC	Bar Socket 22UR Series
GNBC121E-UC GNBC122E-UC	Bar Socket 24UR Series
GNBC211E-UC GNBC212E-UC	Bar Socket 30UR Series

- Contact your distributor for the accessories above and other optional accessories.

5. BEFORE USE

WARNING

- **Check the following contents before connecting the plug into a power source.**

Failure to follow these instructions may result in serious injury due to accidental starting,

- Inspection of the wrench

Check for any deformation, crack or damage on the wrench body, sockets and accessories before use. Do not use the wrench if any problem is found on items listed above.

Make sure that set screws are securely fastened.

Loose installation may result in accidents and personal injury.

See “CHANGING ACCESSORIES” on page (⇨ P.21)

- Make sure to use adequate power supply.

Use adequate power source as indicated on the rating plate.

- Choose Socket

Make sure to use to correct socket suitable for the product to be tightened.

- Install Socket

Socket should be securely installed on the wrench.

Loose installation may result in accidents and personal injury.

See “CHANGING ACCESSORIES” on page (⇨ P.21)

- Warm up the wrench

Implement warm up procedure before operation.

 CAUTION

- Warm up procedure with no-load should be carried out about 5 minutes before operation. Especially, when the wrench is used at low torque setting under low temperature (0~10°C), the warm up procedure with no-load must be carried out at least 5 minutes. In this case, the torque setting dial should be set at Maximum.
 - After the warm up procedure is finished, set the desired torque and squeeze the trigger switch to check the activation of the wrench.

6. CHANGING ACCESSORIES

- Remove bar socket from the wrench by unscrewing set screws with (-) driver. Do not remove the set screws completely from outer socket holder.

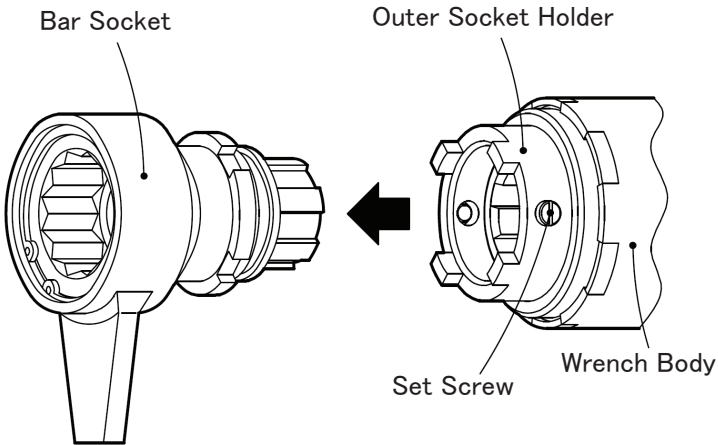

- Select adequate bar socket for the bolts being tightened.
i.e. Use TONE genuine 7/8" bar socket for tightening 7/8" high strength hexagonal bolts/nuts.
- Mount the bar socket on the wrench body and remove the gap between the bar socket and the wrench body.

Fasten the set screws only after the gap is completely removed.

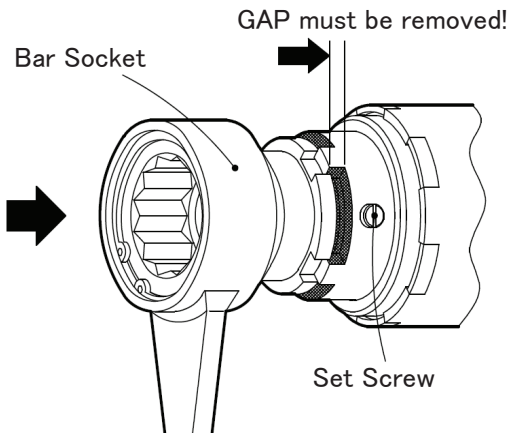

- Pull the bar socket in order to confirm that the bar socket was mounted on the wrench body completely.

 **WARNING**

- **There should be no gap between the socket assembly and the wrench.**

A gap invites accidents or breakage of the sockets or the wrench body.

7. OPERATING PROCEDURE

1. Tightening Operation

- ① Set the change lever or switch to “R” (clockwise) position.

※When tightening left handed screw, set the lever or switch to ”L”(counterclockwise) position.

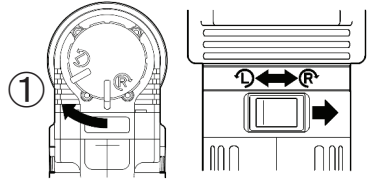

- ② Adjust the torque setting dial to target torque with (-) a screw driver.

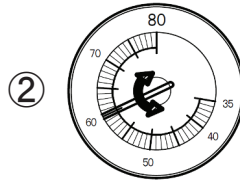

- ③ Slide the socket over nut completely by turning the internal gear.

※When the wrench starts, reaction bar turns in the direction opposite to the rotation of nut.

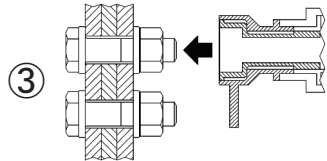

- ④ Squeeze the trigger switch to start. The reaction bar stops at adjacent material and tightening starts.

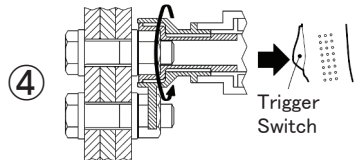

- ⑤ When the target torque is reached, the wrench shuts off automatically.

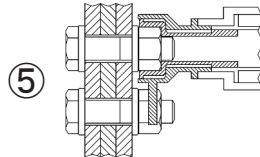

2. Loosening Operation

- ① Set the change lever or switch to “L”
(counterclockwise) position.

※ When tightening left handed screw, set the lever or switch to “R”(clockwise) position.

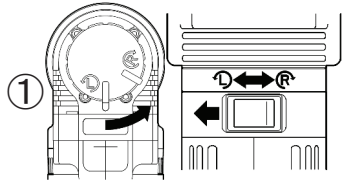

- ② Adjust the torque setting dial to the maximum torque with (-) a screw driver.

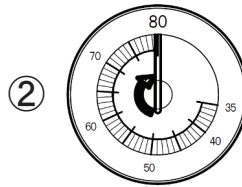

- ③ Slide the socket over nut completely by turning the internal gear.

※ When the wrench starts, reaction bar turns in the direction opposite to the rotation of nut.

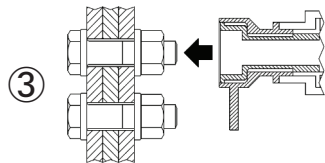

- ④ Squeeze the trigger switch to start.
The reaction bar stops at adjacent material and loosening starts.

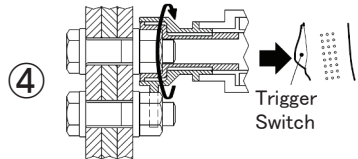

- ⑤ When loosening operation is done, release the trigger switch to stop the wrench.

* In the case that the nut is not loosened, stop the operation immediately since the nut may be tightened by a higher torque than that of the wrench.

Failure to follow these instructions may result in malfunction.

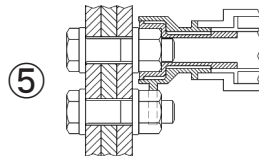

 **DANGER**

- **Never put hand in the turning circle of reaction bar during operation. The reaction bar rotates in the reverse direction.**

Negligence might cause accidents or injury.

 **WARNING**

- **Set target torque as well as the change lever or switch while electric motor is stopping.**

Failure to follow these instructions may result in accidents or injury.

- **Confirm the position of the change lever or switch to avoid the mistake of tightening direction.**

- **Never tighten the same bolt/nut twice. (Never apply too much torque to the same bolt/nut.)**

Failure to follow these instructions may result in breakage of the bolt/but, malfunction and personal injury.

8. TIGHTENING TORQUE

1. Adjustment of tightening torque

■ Graduations of the torque setting dial are just a guidance.

For more precise tightening, use dial type TORQUE WRENCH to adjust torque setting dial.

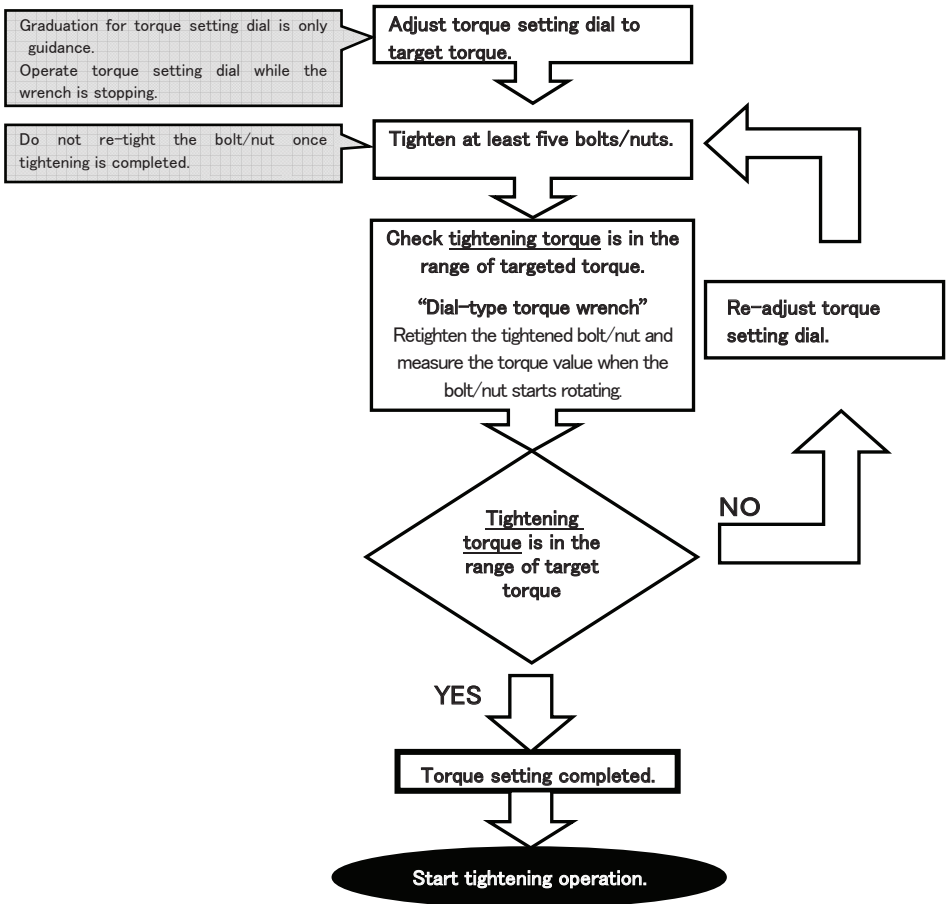

○ Tightening Torque may differ by conditions.

Torque setting has to be done daily before operation and when tightening conditions change.

○ Turn off the motor before set target torque.

○ In order to prevent malfunction as well as over torque, never tightening the same bolts / nuts twice.

2. Tendencies that tightening torque may differ.

Tightening torque varies depending on tightening conditions.

Tendency shown as below.











Factors at Tightening Conditions	Possibility
<ul style="list-style-type: none">- When connection is soft (gasket, rubber, glass & etc in between the steels)- When bolt length is extremely long,- When bolt diameter is small.- When bolt grades are under 8.8 or 10.9- When friction coefficient of the bolt is high- When bolt or washer is stripped during tightening	Tightening Torque becomes Low
<ul style="list-style-type: none">- When connection is hard- When bolt diameter is large- When bolt length is short- When water or oil is adhered on the bolt- When tightened bolt is tightened again (over tightened)- When voltage is lower than rated voltage of the wrench	Tightening Torque becomes High
<ul style="list-style-type: none">- When gaps between the connection is large- When Tightening bolts/nuts from tilt position	Result in imprecise tightening

9. EXPLANATION ON LED INDICATION















- The NUT RUNNER is provided with GREEN and RED LED lights that indicate whether the tightening operation has been successfully completed or any trouble has occurred.

 : Lights Out
   : Light On
  : Quick On & Off (5 times/sec)
 : On & Off (2 times/sec)
  : Slow On & Off (1 times/sec)

Normal Condition

Indication	LED Meaning	Indication	LED Meaning
  ↓ After 1 sec.  	Power ON ↓ "Ready"	  ↓ Start Tightening   ↓ Complete Tightening  	No-load operation ↓ Tightening operation ↓ Tightening Finished

Trouble Detected

Indication	LED Meaning	Remedy
 	<ul style="list-style-type: none"> Tightening was not completed correctly. The trigger switch was released before tightening was completed. Tighten the same bolt twice. 	<ul style="list-style-type: none"> Check the bolt and nut to be tightened. Do not release the trigger switch during the tightening operation. Never tighten the same bolt twice.
	  ↓ Reset (Release the trigger switch)   Ready	<Method of Reset> * To reset the wrench, release the trigger switch. The wrench is now ready.
  -----   -----   ↓ Alternation  	Malfunction of the wrench.	Need to repair. Contact your distributor.

10. INSPECTION & MAINTENANCE

WARNING

- **Disconnect plug from power source before inspection and maintenance.**

Accidental starting invites serious injury.

- Clean dust and debris from the socket assembly and the socket holder periodically.
- Use only a damp cloth to clean the wrench and socket assembly since certain cleaning agents and solvents are harmful to those parts. Some of these include: benzene, thinner, gasoline, etc.
- Never put solvents into the exhaust vent.
- Store the wrench in the metal case after operation and keep it dry.
- Carbon brushes must be regularly inspected and replaced with the new genuine TONE carbon brushes when the brush length becomes less than 5mm (3/16") or 6mm (1/4").
 - * Carbon brushes are placed in two positions.
 - * Indicate the wrench model when carbon brushes are needed because carbon brushes differ from model to model.

New

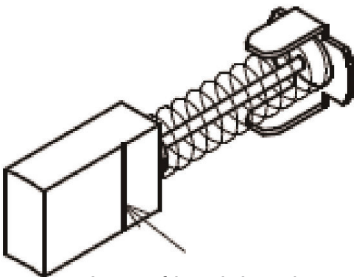

Limit of brush length

Time to Change!!

Less than 6mm(1/4")

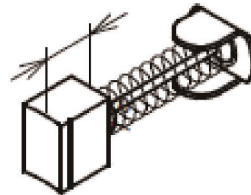

- Replace carbon brush as the drawing below.

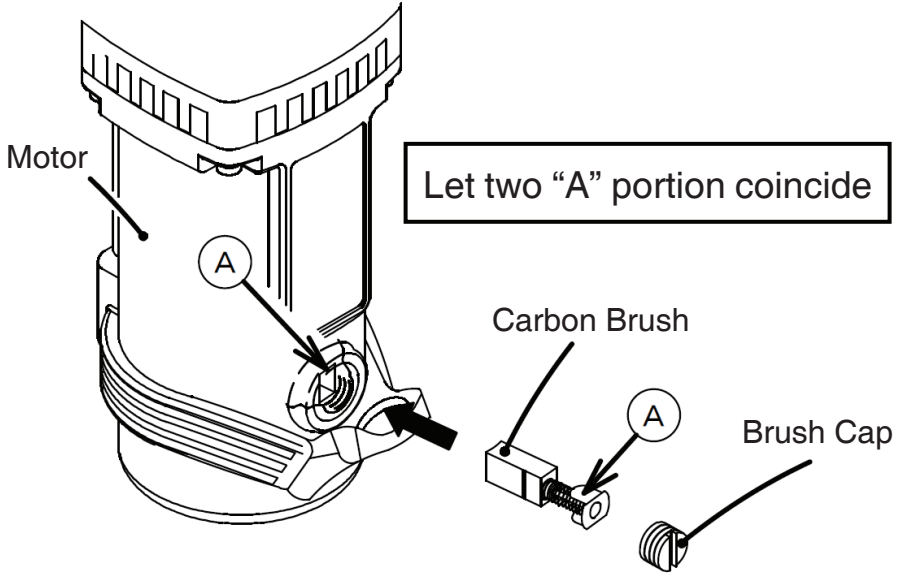

- Overhaul must be carried out every 6 months or 10,000 tightening, whichever comes first. Contact your distributor for overhaul.

11. FEATURE

Feature

- Double Insulated Electric Wrench.
- Short-nosed Corner Type Nut Runner.

12. SPECIFICATIONS

Specifications

Model	GNBC81E-UC	GNBC121E-UC	GNBC211E-UC
Frequency	50-60Hz		
Voltage (Single Phase)	110-120V		
Max Current	13.5A	14.5A	14.5A
Max Power	1550W	1650W	1650W
Max Torque	600lb·ft	900lb·ft	1550lb·ft
Controllable Torque Range	250~600lb·ft	360~900lb·ft	750~1550lb·ft
No-load Speed	17min ⁻¹	11min ⁻¹	6min ⁻¹
Repeated Accuracy*	±5%		
Main Body Weight	5.3kg	5.8kg	7.3kg

* Repeated accuracy is the percentage of variation of tightening torque under the same torque setting and operational condition.

- The weight excludes the socket, the cord and the control box.

13. AFTER SALES SERVICE

- Use the wrench properly in accordance with the cautions and warnings mentioned in this instruction manual.
- If there is a tool failure, provide the model number, serial number and date of purchase along with the details of the failure when contacting your distributor.

CAUTION

- **Do not use the wrench when it is malfunctioning or there is a, deficiency in the wrenches performance, personal injury or property loss is foreseen.**

If possible, have a backup wrench on-hand.

TONE[®] TONE CO., LTD.



1-57, MINATOMACHI 2-CHOME, NANIWA-KU,
OSAKA 556-0017, JAPAN,

Web Site: <http://www.tonetool.co.jp>

e-mail: overseas@tonetool.co.jp

● Specifications and the design are subject to change without notice. ●