

# **tone**® SIMPLE TORQON

## **INSTRUCTION MANUAL**

No.2410

**TO BE  
PRESERVED**

MODEL

STC50AE / STC50TE

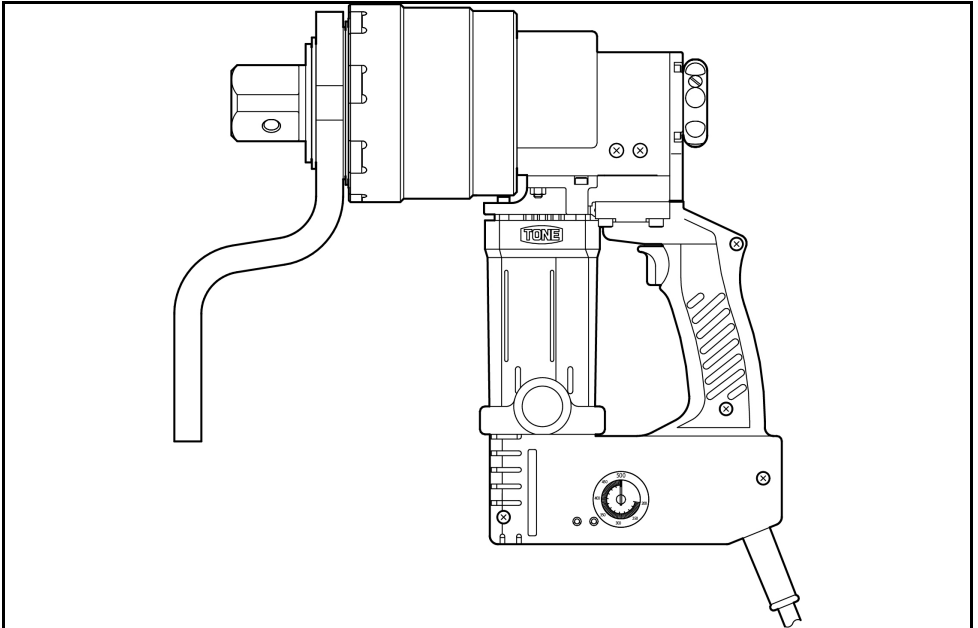

### **⚠ CAUTION**

Read and fully understand all the instructions before use.  
Keep this manual in designated place for easy and quick reference.  
The models mentioned on this manual are designed for use outside Japan.  
Warranty shall be void if above mentioned models are use in Japan.

# **TONE CO., LTD.**

## PREFACE

Thank you for purchasing **SIMPLE TORQON** .

- Upon receipt, check and confirm the following:
  - Check any transport damages.
  - Check for any loose or lost screws and bolts.
  - Check the model as per order.
  - Check all the accessories are contained.

If any problems are found, contact your distributor.

- Read this instruction manual carefully before use.  
Full understanding of manual is essential to prevent personal injury or malfunction.
- Keep this manual in a bag attached to the back of metal case lid for easy and quick reference.
- If manual or warning label is lost or becomes illegible, or if additional manual is required, contact your distributor.

If you have any questions about the products or the contents of this instruction manual, contact your distributor.



- This manual is only applicable to outside Japan.

# SAFETY INSTRUCTION

This manual specifies three (3) basic safety instructions:



- Instructions are classified by degree of risk and described as follows:

	Danger is used to indicate threatening dangerous or unsafe practices which could immediately result in severe personal injury or death in the worst case.
	Warning is used to indicate hazardous or unsafe practices which could result in severe personal injury or death in the worst occasion.
	Caution is used to indicate hazardous or unsafe practices which could result in personal injury or product or property damage.

Even if the risk is classified as  , risk could become more serious result depending on conditions. Make sure to follow all instructions when using.

## TABLE OF CONTENTS

<u>1. GENERAL SAFETY INSTRUCTIONS</u>	<u>4</u>
<u>2. APPLICATION</u>	<u>7</u>
<u>3.  PRECAUTIONS FOR USE</u>	<u>7</u>
<u>4. PART NAME, EXTERNAL DIMENSIONS</u>	<u>18</u>
<u>5. BEFORE USE</u>	<u>20</u>
<u>6. CHANGING ACCESSORIES</u>	<u>21</u>
<u>7. OPERATING PROCEDURE</u>	<u>24</u>
<u>8. METHOD OF TORQUE SETTING</u>	<u>27</u>
<u>9. EXPLANATION ON LED INDICATIONS</u>	<u>29</u>
<u>10. INSPECTION &amp; MAINTENANCE</u>	<u>30</u>
<u>11. SPECIFICATIONS</u>	<u>32</u>
<u>12. AFTERSALES SERVICE</u>	<u>32</u>

# 1. GENERAL SAFETY INSTRUCTIONS

## WARNING

When using electric tools, basic safety precautions, including the following, should always be followed to reduce the risk of fire, electric shock and personal injury.

Read all these instructions before operating this product and keep these instructions.

## SAVE THESE INSTRUCTIONS

### 1) Work area

- a) Keep work area clean and well lit. Cluttered and dark areas invite accidents.
- b) Do not operate power tools in explosive atmospheres, such as in the presence of flammable liquids, gases or dust. Power tools create sparks which may ignite the dust or fumes.
- c) Keep children and bystanders away while operating a power tool. Distractions can cause you to lose control.

### 2) Electrical safety

- a) Power tool plugs must match the outlet. Never modify the plug in any way. Do not use any adapter plugs with earthed (grounded) power tools. Unmodified plugs and matching outlets will reduce risk of electric shock.
- b) Avoid body contact with earthed or grounded surfaces such as pipes, radiators, ranges and refrigerators. There is an increased risk of electric shock if your body is earthed or grounded.
- c) Do not expose power tools to rain or wet conditions. Water entering a power tool will increase the risk of electric shock.
- d) Do not abuse the cord. Never use the cord for carrying, pulling or unplugging the power tool. Keep cord away from heat, oil, sharp edges or moving parts. Damaged or entangled cords increase the risk of electric shock.
- e) When operating a power tool outdoors, use an extension cord

suitable for outdoor use. Use of a cord suitable for outdoor use reduces the risk of electric shock.

### **3) Personal safety**

- a) Stay alert, watch what you are doing and use common sense when operating a power tool. Do not use a power tool while you are tired or under the influence of drugs, alcohol or medication.  
A moment of inattention while operating power tools may result in serious personal injury.
- b) Use safety equipment. Always wear eye protection. Safety equipment such as dust mask, non-skid safety shoes, hard hat, or hearing protection used for appropriate conditions will reduce personal injuries.
- c) Avoid accidental starting. Ensure the switch is in the off position before plugging in. Carrying power tools with your finger on the switch or plugging in power tools that have the switch on invites accidents.
- d) Remove any adjusting key or wrench before turning the power tool on. A wrench or a key left attached to a rotating part of the power tool may result in personal injury.
- e) Do not overreach. Keep proper footing and balance at all times. This enables better control of the power tool in unexpected situations.
- f) Dress properly. Do not wear loose clothing or jewelry. Keep your hair, clothing and gloves away from moving parts. Loose clothes, jewelry or long hair can be caught in moving parts.
- g) If devices are provided for the connection of dust extraction and collection facilities, ensure these are connected and properly used. Use of these devices can reduce dust related hazards.

### **4) Power tool use and care**

- a) Do not force the power tool. Use the correct power tool for your application. The correct power tool will do the job better and safer at the rate for which it was designed.
- b) Do not use the power tool if the switch does not turn it on and off. Any power tool that cannot be controlled with the switch is dangerous and must be repaired.

- c) Disconnect the plug from the power source before making any adjustments, changing accessories, or storing power tools. Such preventive safety measures reduce the risk of starting the power tool accidentally.
- d) Store idle power tools out of the reach of children and do not allow persons unfamiliar with the power tool or these instructions to operate the power tool. Power tools are dangerous in the hands of untrained users.
- e) Maintain power tools. Check for misalignment or binding of moving parts, breakage of parts and any other condition that may affect the power tools operation. If damaged, have the power tool repaired before use. Many accidents are caused by poorly maintained power tools.
- f) Keep cutting tools sharp and clean. Properly maintained cutting tools with sharp cutting edges are less likely to bind and are easier to control.
- g) Use the power tool, accessories and tool bits etc., in accordance with these instructions and in the manner intended for the particular type of power tool, taking into account the working conditions and the work to be performed. Use of the power tool for operations different from intended could result in a hazardous situation.

## **5) Service**

- a) Have your power tool serviced by a qualified repair person using only identical replacement parts. This will ensure that the safety of the power tool is maintained.

## 2. APPLICATION

- TONE SIMPLE TORQON is an electric tool for tightening hexagonal bolts.

## 3. PRECOUTIONS FOR USE

- To prevent accidents, personal injury and etc, read and follow all instructions listed below.

### DANGER

- **Beware of electric shock when operating at high place.**
- Failure to follow this instruction may result in fall down accidents.



**⚠ DANGER**

- **Never put hand in the turning circle of reaction bar during operation. The reaction bar rotates in the reverse direction.**
- If the wrench is started, the reaction bar will turn in the direction opposite to the rotation of nut. There is a risk that finger might be pinched by reaction bar and reaction-member.

Negligence might cause accidents or injury.

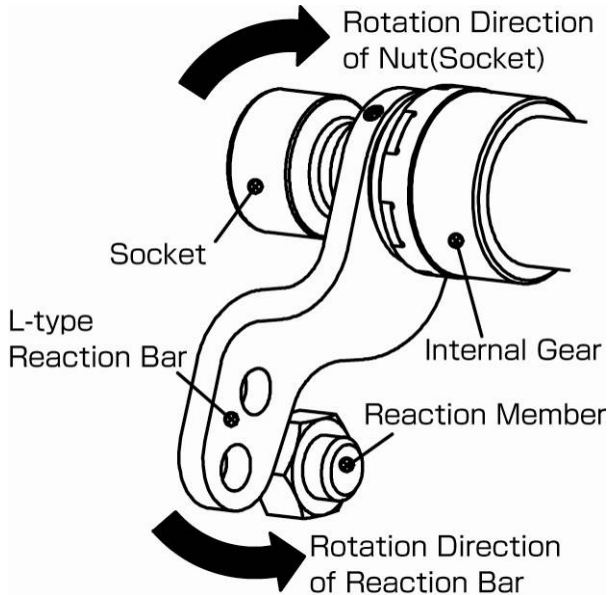

**⚠ WARNING**

● **Insert socket securely to the depth of nut.**

- If insufficient, it might damage socket and cause personal injury

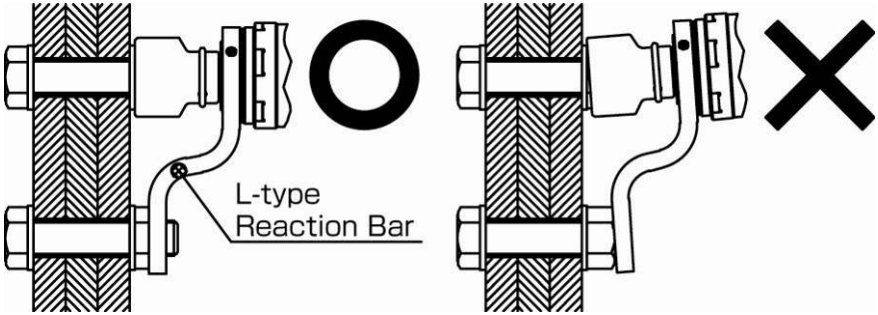

Negligence might cause accident, breakage or injury.

---

● **Beware of electric shock.**

- Never use wrench in damp or wet place or in rainy or snowy condition.
- Might cause electric-shock, fire or electricity leakage.

● **Hold the wrench and grip of firmly when in operation.**

- TN Wrenches stop automatically with huge reaction force just after tightening bolts completely.

Failure to follow this instruction may result in personal injury.

---

● **Electric cord must be regularly inspected.**

- If there is damage on electric cord, please ask your distributor for repair.

Failure to follow this instruction may result in electric shock or electric leakage.

## WARNING

- **Never use the wrench around the place where gasoline, gas, thinner, benzene, etc., are stored.**

- Do not use the wrench around flammable substances to avoid the accidental fire caused by the spark out of the electric motor.

- **Beware of fall down accidents when working at a high place.**

- Wear safety belt
- Provide safety net or canvas as safe guarding against falling items.
- Confirm that no one is underneath the working site before operation.
- Stop operation when physically or mentally tired.

Failure to follow these instructions may result in fall down accidents.

---

- **Avoid overloading.**

- Use the wrench and its accessories within the rated specifications. Overloaded wrench and its accessories may result in malfunction of the wrenches, accidents or personal injury.
- 

- **Properly install sockets and reaction bars as described in this manual.**

- Incomplete installation may result in accidents and personal injury. See “CHANGING ACCESSORIES” on page 21.

- **Avoid accidental Starting.**

- Ensure that the switch is in the off-position before plugging into power source.
- Never carrying the wrench with your fingers on the switch when the plug is connected to power source.

 **WARNING**

● **Disconnect the plug from the power source when:**

- Not in use.
- Changing accessories.
- Inspection and maintenance.
- Or other danger is foreseen.

Failure to follow these instructions may result in accidental starting and personal injury.

---

● **Do not disassemble or modify the wrench.**

- Disassembly or modification made by unauthorized personnel may result in malfunction or personal injury.
  - Disassembly & Re-assembly work is permitted for the following expendables: Sockets, O-Ring, Pin, Reaction Bar, Set Screws, and Carbon Brushes.
- 

● **Store wrench in the metal case and keep it at the designated place when not in use.**

- Store wrench in lockable dry location to keep any unauthorized personnel away.

Failure to follow this instruction may result in malfunction or accidents.

---

● **Immediately stop using the wrench and disconnect the plug when unusual sound, vibration or smell is detected.**

- Contact your distributor immediately.

Failure to follow this instruction may result in serious injury.

 **WARNING**

● **Contact your distributor for repair service.**

- Repair work should only be carried out by a qualified serviceman.
  - Repair work done by an inexperienced person may cause accidents, injury or malfunction.
- 

● **Check the following items before operation.**

- Check for any deformation, crack or damage on the wrench body, sockets, electric cord, plug and etc
  - Do not use the wrench if any problems are found on items listed above.
  - Make sure that socket assembly is correctly installed on the wrench.
  - Make sure that set screws are securely fastened. Loose installation may result in accidents and personal injury.
- 

● **Use appropriate power source as indicated on the rating plate.**

Failure to follow this instruction may result in fire or burn accidents.

---

● **Immediately check the wrench when it is dropped down or banged.**

- Check for deformation, crack, damage and other abnormality. Stop using the wrench if any abnormality is found.

Continued use of fault wrench may result in accidents and personal injury.

**⚠ WARNING**

● **Check if leakage breaker is available together with earth connection.**

- Recommended leakage breaker: Rating capacity at 15mA and acting time below 0.1sec.

Failure to follow this instruction may result in electric shock or fire.

---

● **Grounding required during operation.**

- Failure to follow this instruction may result in increasing the risk of electric shock or fire if the wrench breaks down during operation.
- 

● **Do not connect earth leads to gas pipe.**

- Negligence might cause explosion or fire which might lead to serious injury or death.
- 

● **If extension cable is used, apply those with earth and 3-P cable.**

- Use one of leads for earth and connect to earth on TN wrench side.

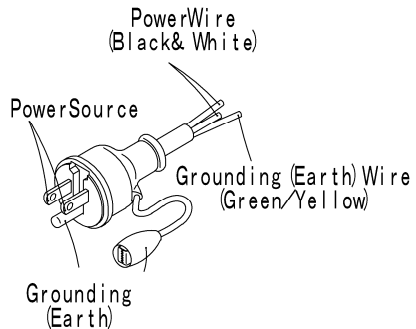
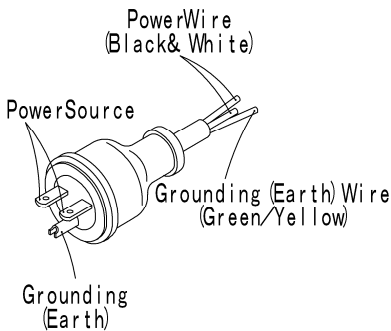

 CAUTION

● Follow the instructions below when using generators.

- Use 50–60Hz sinusoidal power supply without high harmonic wave. Power supply including high harmonic wave may cause malfunction or breakage of the wrench.
- Use high capacity generators.  
Almost 2kW (2kVA) is required per one wrench.
- The operating voltage must remain within  $\pm 10\%$  of the rated voltage at all times.
- Do not use inverter generators.  
Inverter generators may cause malfunction or breakage of the wrench.  
(Inverter Generator: The engine rpm will speed up and slow down automatically due to the wattage being pulled from the generator.)
- Do not use welder generators.
- Welder generators may cause malfunction or breakage of the control base installed in Simple Torqon. Some welder generators produce electrical noise which may make Simple Torqon out of control.
- Do not use welders along with Simple Torqon.  
Simple Torqon may be out of control due to extraordinary electrical noise even if welders are connected to other generators that Simple Torqon is not connected to.

 CAUTION

- **Use commercial power supply.**
- **Keep work area clean.**
  - Cluttered areas and benches invite accidents.
- **Keep children away.**
  - Do not let children touch TN wrenches and electric cord.
  - All visitors should be kept away from work area.
- **Secure work area.**
  - Keep body stance balanced and firmed.
  - Never wrap the electric cord around something.
  - Keep work area well lit.
- **Use suitable model for each application.**
  - Do not use Simple Torqon beyond their rated specifications.
  - Do not use Simple Torqon for purpose not intended.
- **Dress properly.**
  - Always wear gloves and non-skid footwear when operating outdoor.
  - Always wear safety helmet.



 **CAUTION**

- **Use genuine accessories or attachments manufactured by Maeda Metal Industries, Ltd.**
  
- **Do not abuse the electric cord.**
  - Never use the electric cord for carrying, pulling, or unplugging the power.
  - Keep the electric cord away from heat, oil, sharp edges or moving parts.
  
- **Keep electric motor well ventilated.**
  - Do not put any foreign materials into the vent.
  - Do not block exhaust vent.
  
- **Maintain wrench.**
  - Keep wrench handle clean, dry and free of oil or grease.
  
- **Do not connect multiple plugs to a single outlet by using multiple outlet adaptors.**
  - Over current may cause fire, accidents or malfunction.
  
- **Provide leakage breaker as a shock guard for each wrench.**

 **CAUTION**

- When using an extension cord, make sure that voltage remains within +/- 10% of the rated voltage at all times.
- When applying extension cord, select shorter extension units than specified below depending on the cross section.

Nominal conducting cable cross section		Max Length	
		110–120 V	110–120 V
H07RN–F	1.25 mm <sup>2</sup>	10 m	20
	2.0 mm <sup>2</sup>	15 m	30
	3.5 mm <sup>2</sup>	30 m	60
AWG 14		50ft(15m)	100ft(30m)
AWG 12		80ft(25m)	160ft(50m)
AWG 10		130ft(40m)	260ft(80m)

- Using extension cord more than Maximum Length may result in malfunction or breakdown due to performance drop of the wrench.

- Observe local laws and rules concerning noise level.

## 4. PARTS NAME, EXTERNAL DIMENSIONS

### Part Name

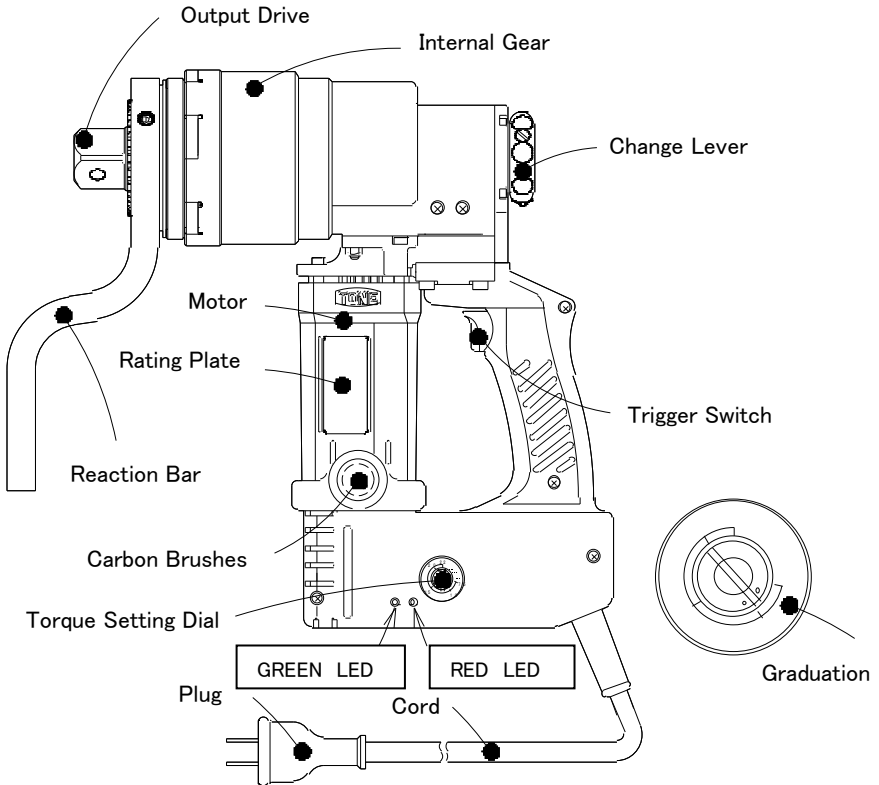

MODEL	ACCESSORIES	QTY
STC50AE STC50TE	○ L-type Reaction Bar *	1
	○ Spirolox(FRSN-70)* Mounted on Main Body	1
	○ Straight type Reaction Bar	1
	○ (-)Driver	1
	○ Metal Case	1
	○ Instruction Manual	1
	○ Connector(220-230V only)	1

### Optional Accessories

- Impact Socket 12AD-Series
- Lifting Device

● Contact your distributor for these optional accessories above.

### External Dimensions

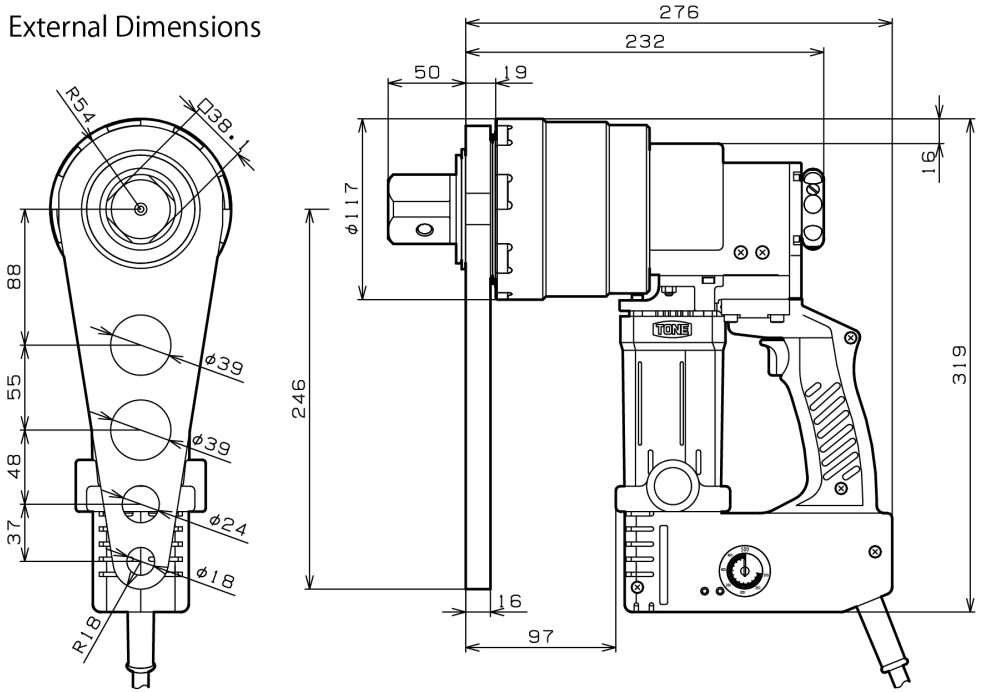

Straight type Reaction Bar

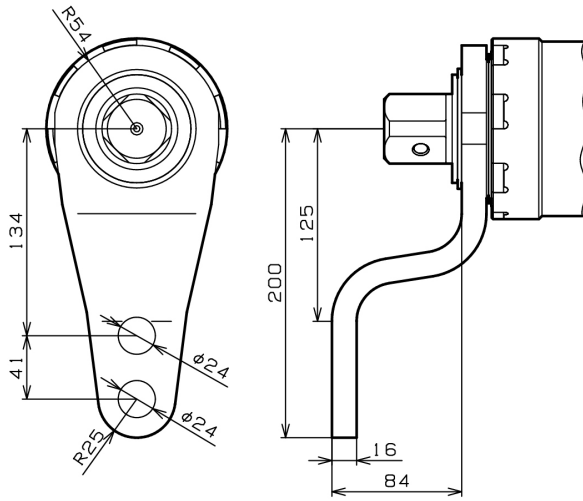

L-type Reaction Bar

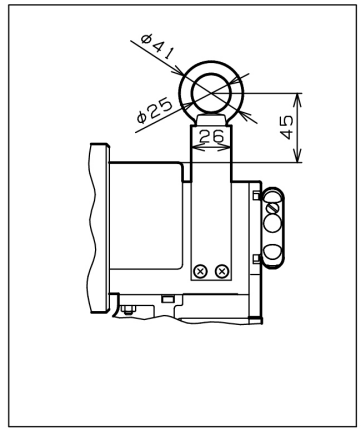

Lifting Device (Optional)

## 5. BEFORE USE

### WARNING

● **Check followings before connecting the plug into power source.**

- Accidental starting invites personal injury.

1. Check for any deformation, crack or damage on wrench body, socket, electric cord, etc. Do not use wrench if any problem is found on items listed above.

Make sure that set screws are securely fastened.

Loose installation may result in accidents and personal injury.

See “CHANGING ACCESSORIES” on page 21.

2. Make sure to use commercial power supply.

Use appropriate power source as indicated on the rating plate.

3. Choose proper impact socket suitable for tightened bolt.

4. Make sure that impact socket is correctly installed on the wrench.

Loose installation may result in accidents and personal injury.

See “CHANGING ACCESSORIES” on page 21.

### CAUTION

● **Implement exercise procedure before operation.**

- Exercise procedure with no-load should be carried out at least 5 minutes before operation.

## 6. CHANGING ACCESSORIES

### 1. Changing Reaction Bar

#### ● Mount Reaction Bar

- ① Mount the reaction bar on the wrench body to fit the spline.
- ② Install spirolox in groove part of the reaction bar.
  - \* At first put the notch as shown and install gradually in a circumferential direction.
- ③ Confirm that the reaction bar is securely mounted.

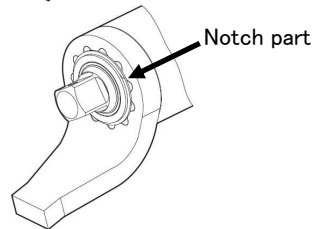
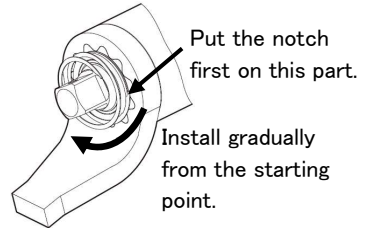
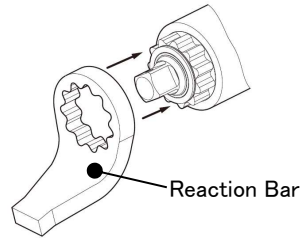

#### ● Remove Reaction Bar

- ① Remove spirolox with (-) screw driver.
- ② Remove reaction bar from the wrench body.

### 2. Changing Socket

#### ● Install Socket

- ① Prepare an adequate size of socket.
- ② Put aside the O-ring and take the pin.
- ③ Align the hole in the socket and the square drive.
- ④ Insert the pin to the hole and place the O-ring on groove.
- ⑤ Confirm that the O-ring is placed and the socket does not fall down from wrench body.

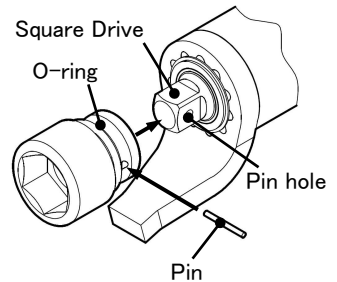

#### ● Remove Socket

- ⑥ Put aside the O-ring and take the pin.

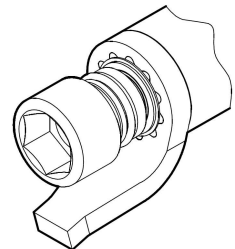

 **WARNING**

● **Do not modify reaction bars.**

- Failure to follow this instruction may result in lack of tightening torque, breakage of bolts/nuts, malfunction and personal injury.

- Contact your distributor for customized reaction bars.

 **WARNING**

- **Confirm if there is no crack, wear or deformation on the impact socket. Personal injury might be invited if the socket is shattered.**
- **Confirm if there is no deformation with O-ring and bend or crack with pin. If something wrong with pin or O-ring, replace them to new one. Personal injury might be invited if the socket falls down.**
- **Confirm if the impact socket is securely mounted by pulling the socket. Inadequate mounting might reduce socket's durability, also cause injury or breakage.**

### 3. Mounting Lifting Device (Optional)

- ① Unscrew CRFH Screw (4pcs) on the Housing.
- ② Install I-bolt in the lifting device and securely tighten by nut.
- ③ Set the lifting device over the Housing.
- ④ Securely tighten CRFH Screw (4pcs) again.

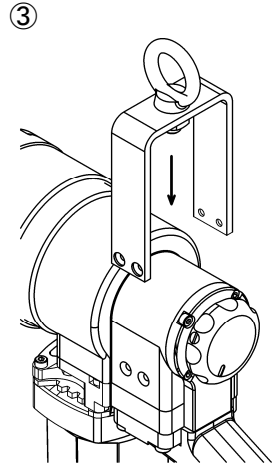
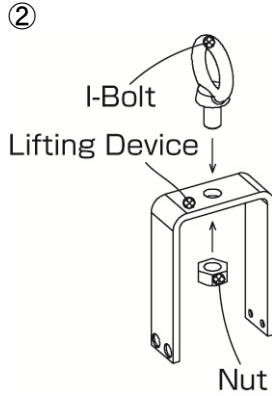
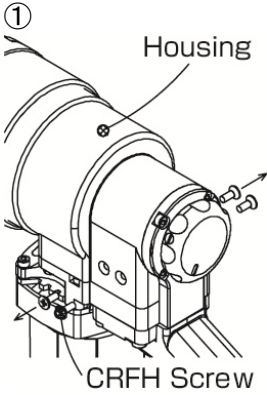

Mounting Lifting Device is done.

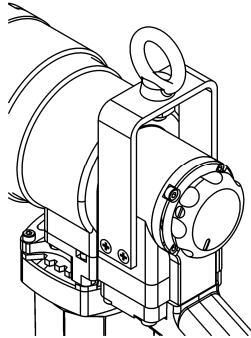
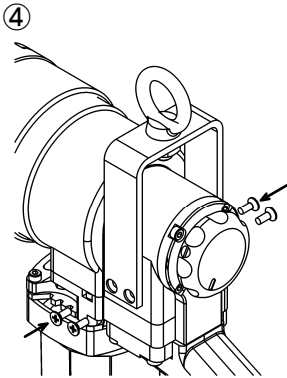



## 7. OPERATING PROCEDURE

### 1. Tightening Operation

- ① Set the change lever to “R” (clockwise) position.

- ② Adjust torque setting dial to target torque with attached (-) driver.

※ Graduations are just a guidance.  
When minute torque control is necessary, confirm torque with torque wrench.

- ③ Slide impact socket over nut completely by turning internal gear.

※ When the wrench starts, reaction bar turns in the direction opposite to the rotation of nut.

- ④ Squeeze trigger switch to start.  
Reaction bar stops at adjacent material and tightening starts.

※ GREEN LED keeps going ON and OFF after beginning of tightening operation until automatic shut-off.

- ⑤ When the target torque is reached, the wrench shuts off automatically.

※ After normal-end, GREEN LED remains ON and the wrench remains READY for next operation  
※ Do not release the trigger switch during tightening operation. The target torque is not reached.

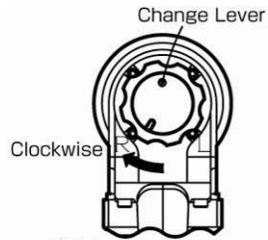

① Set change lever



② Adjust torque setting dial

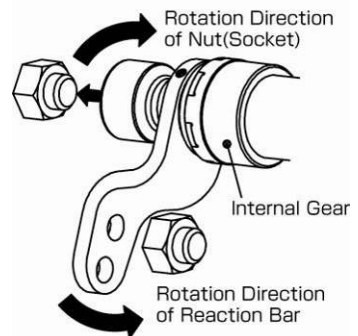

③ Slide impact socket over nut

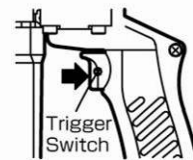

④ Squeeze trigger switch

※ In case that RED LED goes ON and OFF during tightening operation ④&⑤ above, any troubles happen on the wrench. (See Page 29)

## 2. Loosening Operation

- ① Set the change lever to “L” (counterclockwise) position.
- ② Adjust torque setting dial to the maximum torque with attached (-) driver.
- ③ Insert impact socket into nut completely by turning internal gear.

※ When the wrench starts, reaction bar turns in the direction opposite to the rotation of nut.

- ④ Squeeze trigger switch to start. Reaction bar stops at adjacent material and loosening starts. When loosening operation is done, release the trigger switch to stop the wrench.

※ In case that the nut is not loosened, stop the operation immediately since the nut is tightened by higher torque than that of the wrench. Failure to follow this instruction may result in malfunction.

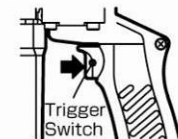
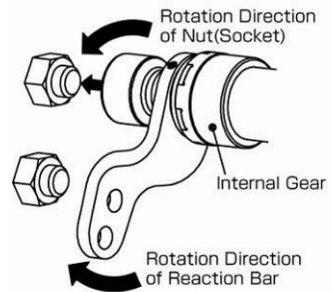
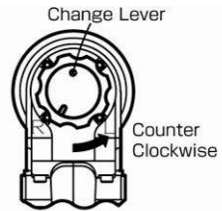

### DANGER

- Never put hand in the turning circle of reaction bar during operation. The reaction bar rotates in the reverse direction.

Negligence might cause accidents or injury.

## ⚠ WARNING

- Confirm the position of the change lever before starting tightening or loosening operation.
- Set target torque as well as the change lever while electric motor is stopping.

Failure to follow this instruction may result in accidents or injury.

- In order to prevent malfunction as well as over torque, never tightening the same bolts/nuts twice.

## ⚠ CAUTION

- Reaction force must be taken by area beyond “a” dimension when L-type reaction bar is used. See table below.

Failure to follow this instruction may result in malfunction and insufficient performance.

MODEL	a(mm)
STC50AE / STC50TE	135

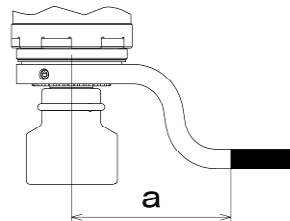

- There should be no gap between the impact socket and the grip.

The gap invites accidents or breakage of sockets or the wrench body.

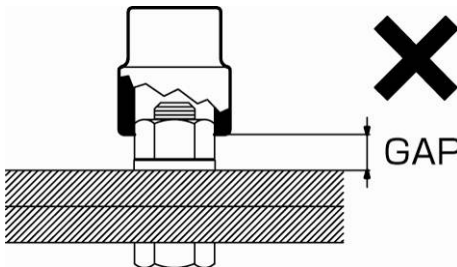

## 8. METHOD of TORQUE SETTING

### 1. Adjust tightening torque

- Graduations of the torque setting dial are just a guidance. Use dial type torque wrench to adjust torque setting dial if minute torque control is necessary.

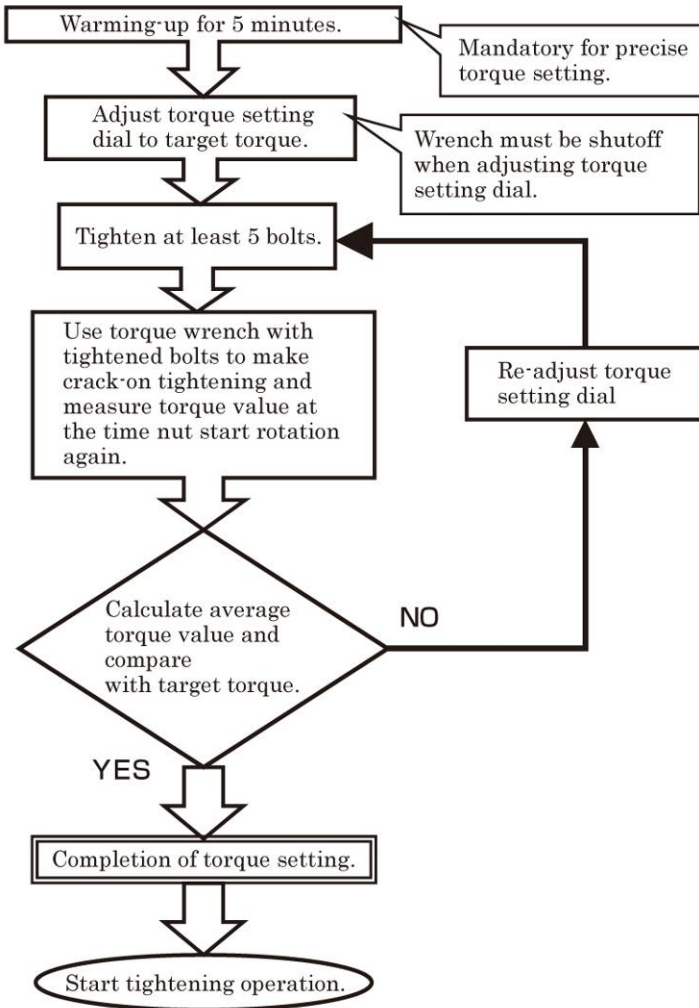

- Tightening Torque may differ by conditions.  
Torque setting has to be done daily before operation and when tightening conditions change.
- Make sure the tightening direction of SIMPLE TORQON when tightening reverse thread bolts/nuts.
- In order to prevent malfunction as well as over torque, never tightening the same bolts/nuts twice.

## 2. Tendencies that tightening torque may differ

Tightening torque varies depending on tightening conditions.  
Tendency shown as below.







Factors at Tightening Conditions	Possibility
<ul style="list-style-type: none"> <li>- When connection is soft (gasket, rubber, glass &amp; etc in between the steels)</li> <li>- When bolt length is extremely long,</li> <li>- When bolt grades are under 8.8 or 10.9</li> <li>- When friction coefficient of the bolt is high</li> <li>- When bolt or washer is stripped during tightening</li> <li>- When voltage is higher than rated voltage of the wrench</li> </ul>	<p>Tightening Torque Becomes Low</p>
<ul style="list-style-type: none"> <li>- When connection is hard</li> <li>- When bolt diameter is large</li> <li>- When bolt length is short</li> <li>- When water or oil is adhered on the bolt</li> <li>- When tightened bolt is tightened again (over tightened)</li> <li>- When voltage is lower than rated voltage of the wrench</li> </ul>	<p>Tightening Torque becomes High</p>
<ul style="list-style-type: none"> <li>- When gaps between the connection is large</li> <li>- When Tightening bolts/nuts from tilt position</li> </ul>	<p>Result in imprecise tightening</p>

## 9. EXPLANATION ON LED INDICATION







- The SIMPLE TORQON is provided with GREEN and RED LED that indicate whether the tightening operation has been successfully completed or not, or any trouble has occurred or not.

 : Lights Out  
   : Light On  
  : Quick On & Off (5 times/sec)  
 : On & Off (2 times/sec)  
  : Slow On & Off (1 times/sec)

### Normal Condition

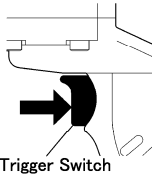
Indication	LED Meaning	Indication	LED Meaning
 ↓ After 1 sec.  80% Mode  100% Mode	Power ON ↓ "Ready"	 ↓ Start Tightening  ↓ Complete Tightening 	No-load operation ↓ Tightening operation ↓ Tightening Finished

### Trouble Detected

Indication	LED Meaning	Remedy
	<ul style="list-style-type: none"> <li>• Tightening is not completed correctly.</li> <li>• Release the trigger switch before tightening is completed.</li> <li>• Tighten the same bolt twice.</li> </ul>	<ul style="list-style-type: none"> <li>• Check the bolt and nut to be tightened already.</li> <li>• Do not release the trigger switch during tightening operation.</li> <li>• Never tighten the same bolt twice.</li> </ul>
 ↓ Reset  Ready	 Trigger Switch	<Method of Reset> * To reset the wrench, squeeze the trigger switch once. And then, the wrench is now ready.
 <hr/>  <hr/>  ↓ Alternation 	Troubles happen on the wrench.	Need to repair. Contact your distributor.

## 10. INSPECTION & MAINTENANCE

### WARNING

● **Disconnect plug from power source before inspection and maintenance.**

○ Accidental starting invites serious injury.

- ① Clean dust and debris from impact socket and square drive periodically.
- ② Use only a damp cloth to clean your SIMPLE TORQON and impact sockets since certain cleaning agents and solvents are harmful to those parts. Some of these include: benzene, thinner, gasoline and etc.
- ③ Never put solvents into the exhaust vent.
- ④ Store SIMPLE TORQON in the metal case after operation and keep it dry.
- ⑤ Carbon-brush must be regularly inspected and replaced with the new genuine carbon brush when brush length become less than 6mm.  
\*Carbon brushes are placed in two positions.  
\*Indicate the wrench model when carbon-brushes are needed because carbon-brush differs from model to model.

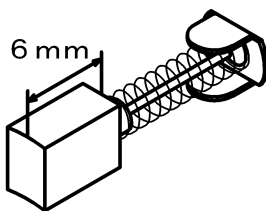

⑥ Replace carbon brush as shown in the following figure.

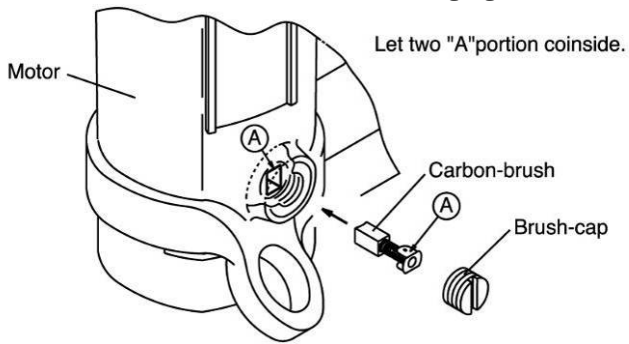

⑦ Overhaul must be carried out every 6 months or 30,000 tightening, whichever comes first. Contact your distributor for overhaul.



## 11. SPECIFICATIONS

Model	STC50AE	STC50TE
Voltage (Single Phase)	115V	220V
Max Current (A)	12A	6A
Max Power (W)	1350W	
Rated Max Torque (lb.ft)	5000 N·m (3700lb.ft)	
Controllable Torque Range	2000~5000 N·m (1500~3700lb.ft)	
Repeated Accuracy	±5%※	
No-load Speed	2.0min <sup>-1</sup> (rpm)	
Main Body Weight (kg)	12.5kg	

※+/- 5% of repeated accuracy is obtained with adequate operating procedure on page 24~26.

- Commutator motor is used on the wrench.
- Control base is used on the wrench.
- Weight excludes socket and cord.

## 12. AFTERSALES SERVICE

- Contact your distributor for available services.
- Provide model, serial number, date of purchase and details of failure when contacting your distributor.

### CAUTION

- Do not use **SIMPLE TORQON** when malfunction, deficiency in wrenches' performance, personal injury or property loss is foreseen.

If possible, prepare backup wrenches beforehand.



# MEMO

---

---

---

---

---

---

---

---

---

---

---

---

---

---

---

---

---

---

---

---

---

---

---

---

**TONE**® **TONE CO., LTD.**



6-25, KOTOBUKI-CHO, KAWACHINAGANO-SHI,  
OSAKA 586-0026, JAPAN

Web Site: <https://www.tonetool.co.jp>  
e-mail: [overseas@tonetool.co.jp](mailto:overseas@tonetool.co.jp)

● Specifications and the design are subject to change without notice. ●